

PRODUCT SPECIFICATION



Part No. : JH-5054WW12S35-T8A-97
High Power LED

Catalog

1.Product Features	P2
2.Dimensions	P2
3.Absolute Maximum Rating	P3
4.Optical Character	P3
5.Optical Character Curves	P4
6.Spectrum Curves	P5
7.Viewing Angle Curves	P5
8.Tape&Reel Packing	P6
9.Soldering Advice	P7
10.Cautions	P8

1.Product Features

- High Brightness W/WW LED
- Plane Package
- Viewing Angle 120 Degree
- Chip Material: IngaN AlGaInP
- RoHS Compliant

2.Dimensions

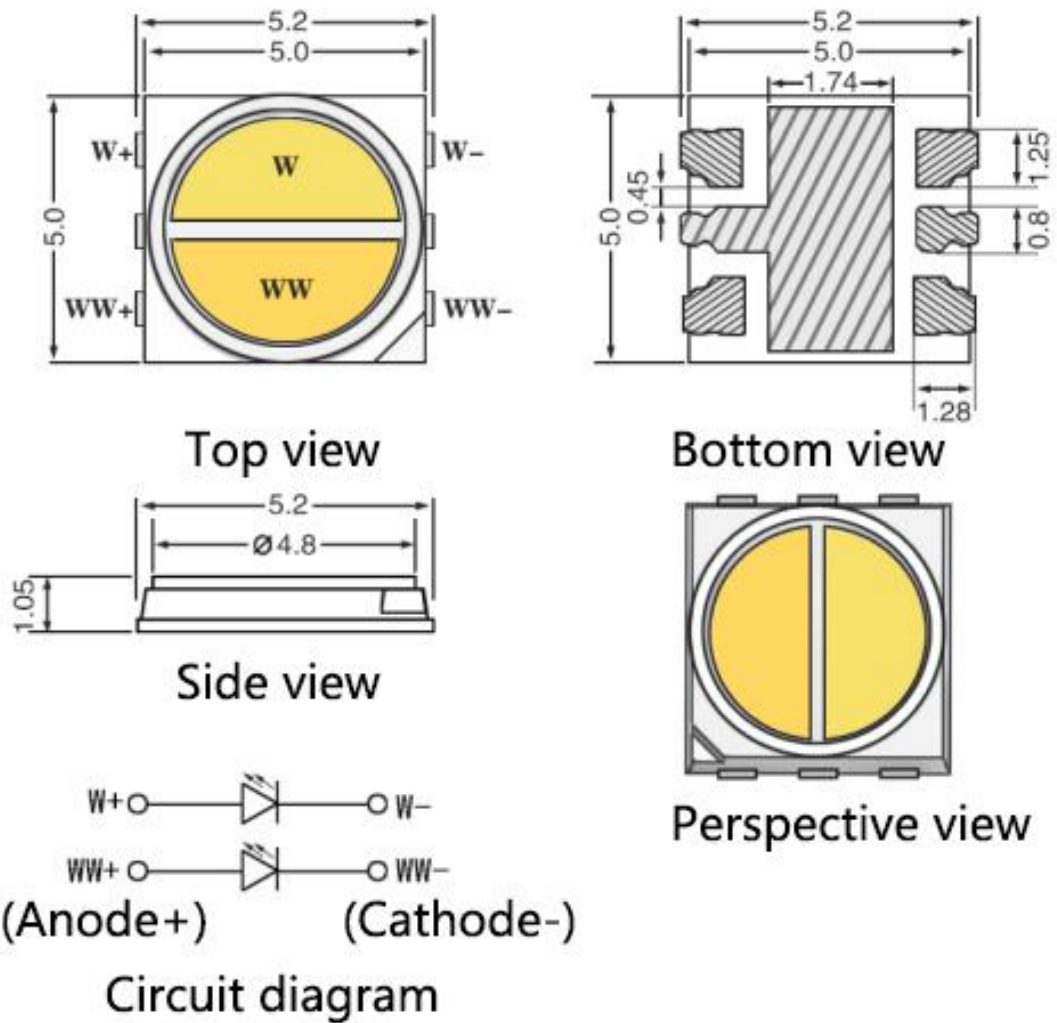

Notes:

1. All dimensions are in millimeters.
2. Tolerance is $\pm 0.1\text{mm}$ unless otherwise noted.

3. Absolute Maximum Rating @ Ta=25° C

Parameter	Symbol	Maximum Rating	Unit
Continuous Forward Current	IF	150	mA
Peak Forward Current (1/10 Duty Cycle, 0.1ms Pulse Width)	IFp	200	mA
Reverse Voltage	VR	5	V
Power Dissipation	PD	0.5	W
Electrostatic Discharge	ESD	1000	V
Operating Temperature Range	TOPR	-25°C to +60°C	
Storage Temperature Range	TSTG	-35°C to +80°C	
Lead Soldering Temperature	TSOL	260°C	

4. Optical Character @ Ta=25° C

Parameter	Symbo	Color	Min.	Typ.	Max.	Unit	Test Condition
Forward Voltage	VF	W/WW	2.8	3.0	3.2	V	IF=150mA
Luminous Flux	Φ	W/WW	30	40	50	Lm	IF=150mA
Color Temperature	Tc	W	5000	5500	6000	K	IF=150mA
		WW	2800	3000	3200	K	IF=150mA
Color rendering index		W/WW	95			\	IF=150mA
Reverse Current	IR				10	μA	VR=5V
Viewing Angle	2θ1/2				120	deg	IF=150mA
Recommend Forward Current	IF(rec)	W/WW			150	mA	

Notes:

Measurement tolerance of forward voltage±0.1V

5. Optical Character Curves

(25 ° Ambient Temperature Unless Otherwise Noted)

Forward Current vs. Forward Voltage
Tc=25C

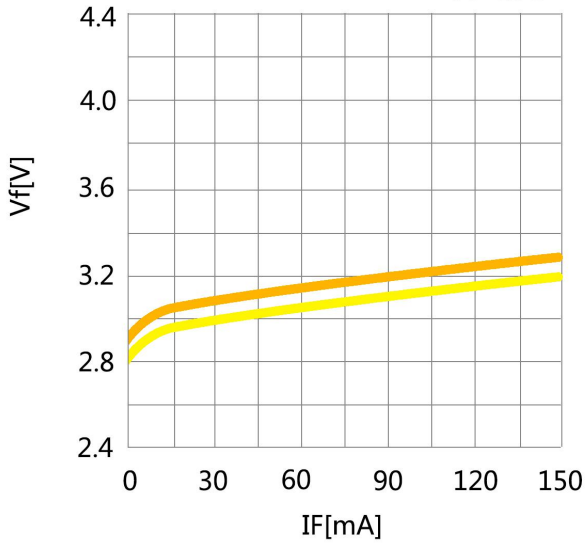

Forward Current vs. Relative Luminous Flux
Tc=25C

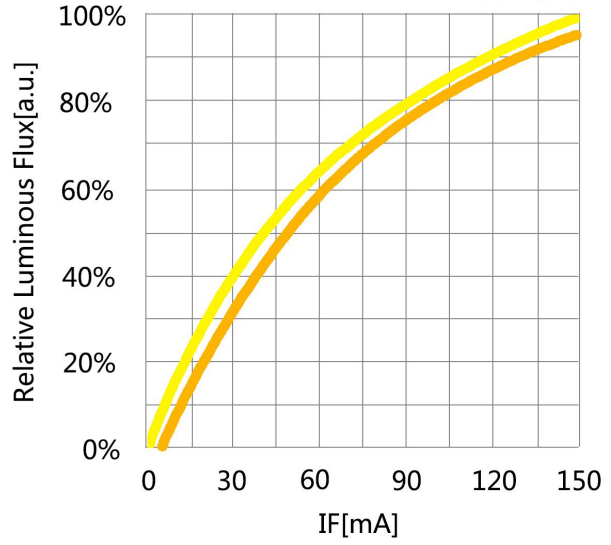

Case Temperature vs. Forward Voltage
If=150mA

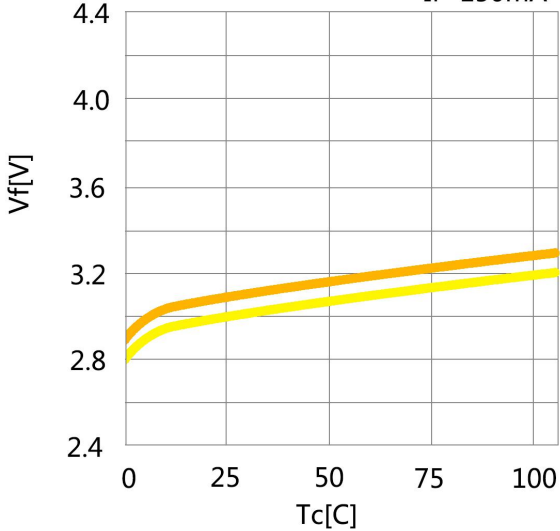

Case Temperature vs. Relative Luminous Flux
If=150mA

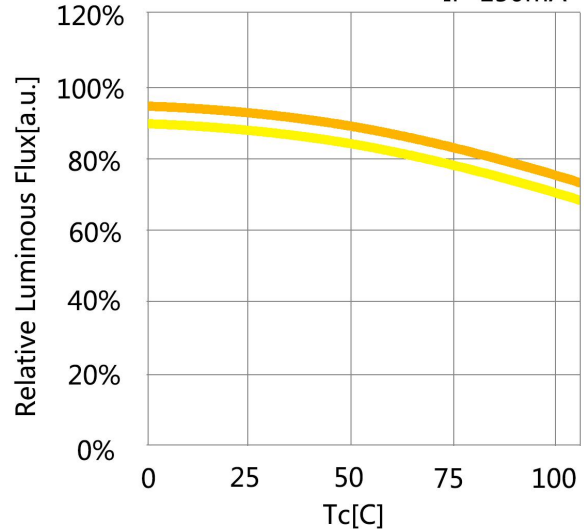

6. Spectrum Curves

IF=150mA

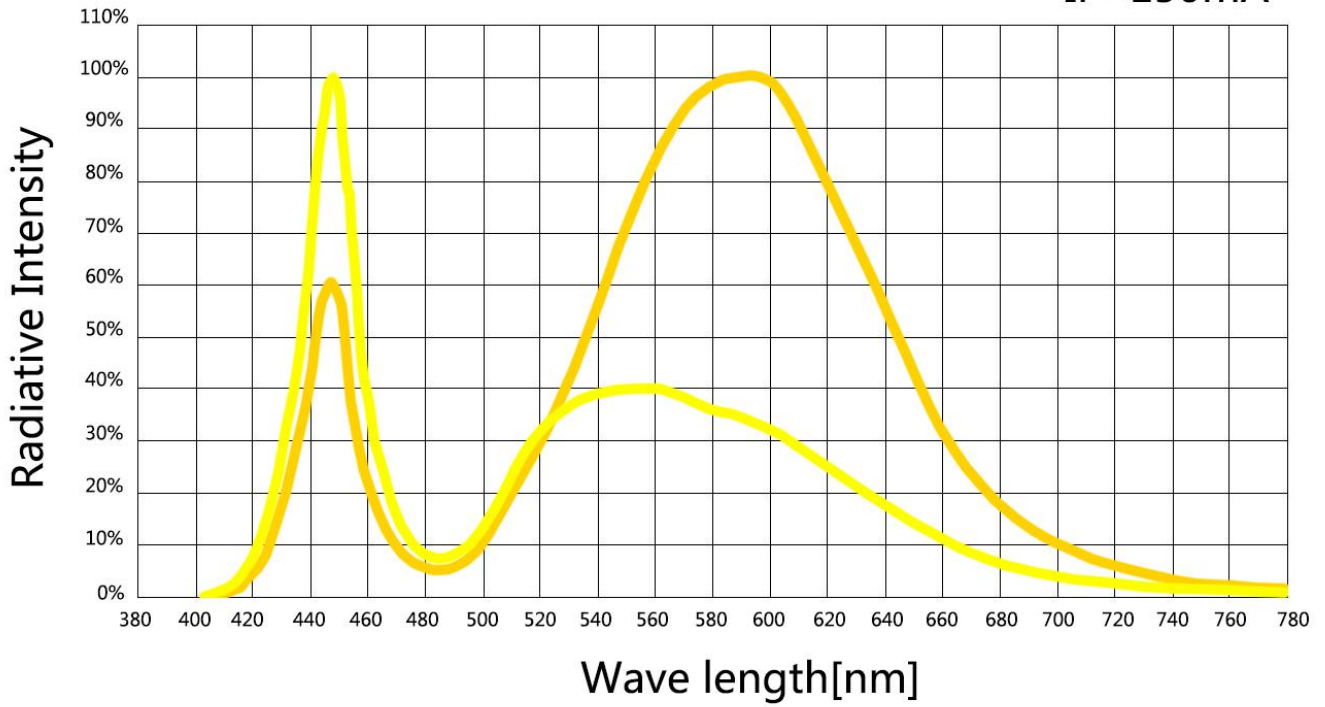

7. Viewing Angle Curves

Radiation Characteristic

IF=150mA

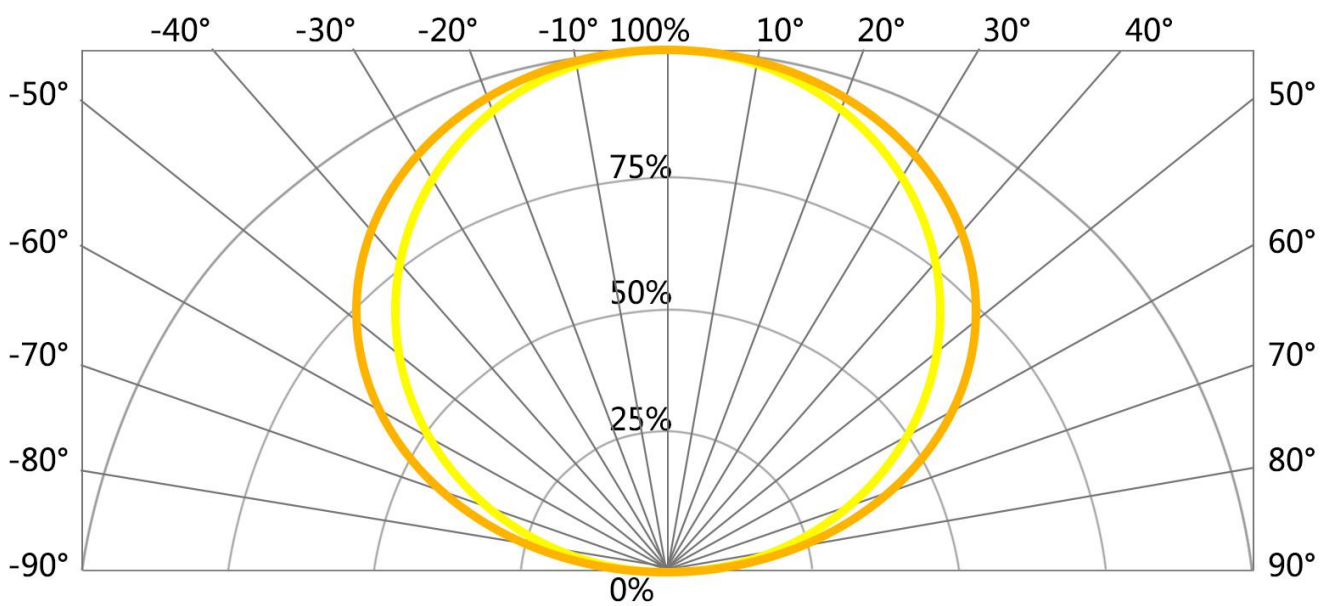

8. Tape & Reel Packing

1. Recommend unpacked LED beads be welded within one day, if not, please vacuumize again and store in an environment of 20-35°C and 30-60% humidity. If can't vacuumize, please store LED beads in moisture proof box, control at 25°C ± 3°C, humidity 50-60%. If unpacked above 1 week, bake at 60 ± 5°C for 10-12 hours before weld.

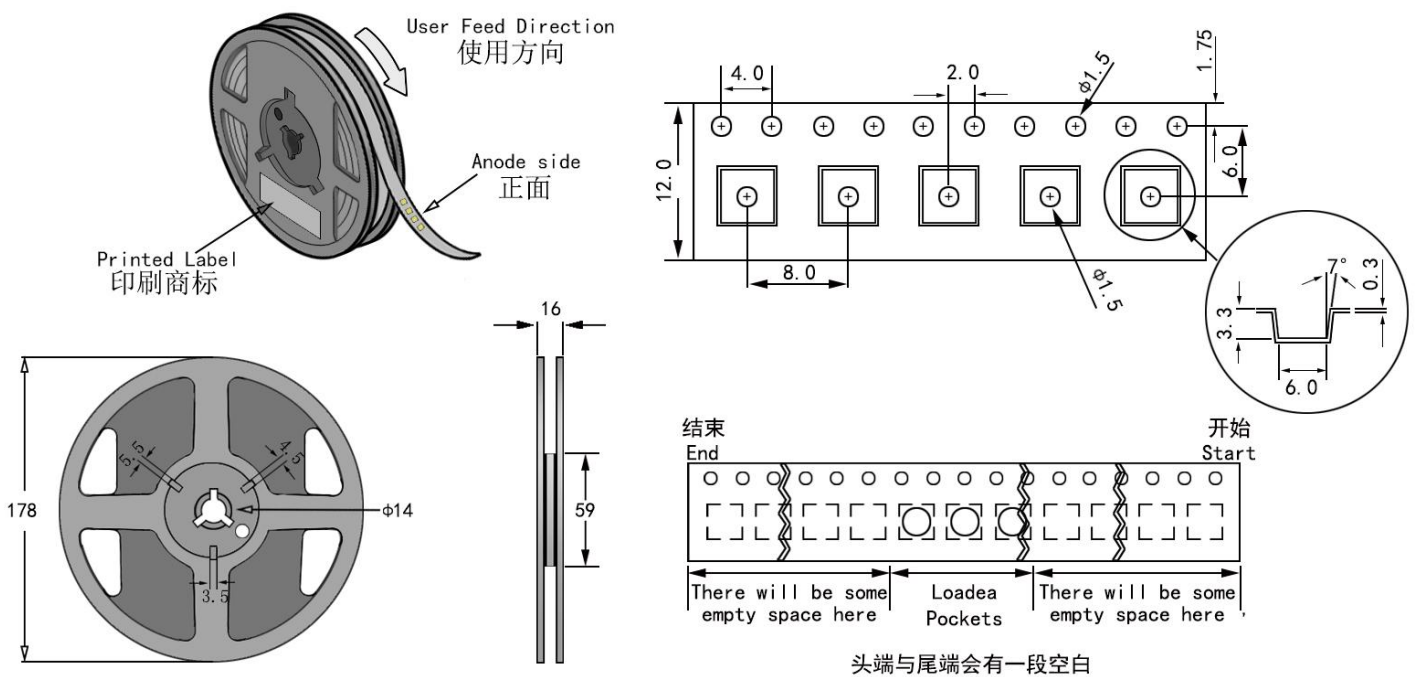

Notes:

1. QTY: 1000pcs/Reel
2. Tolerance ±0.2mm.
3. Package: P/N

9.Soldering Advice

1. When soldering, don't touch the LED appearance gel during, this bad operation will destroy the LED. Moding LED usually use reflow soldering, please refer to the following reflow temperature curve , and recommend the user follow the soldering temperature curve of the solder paste.

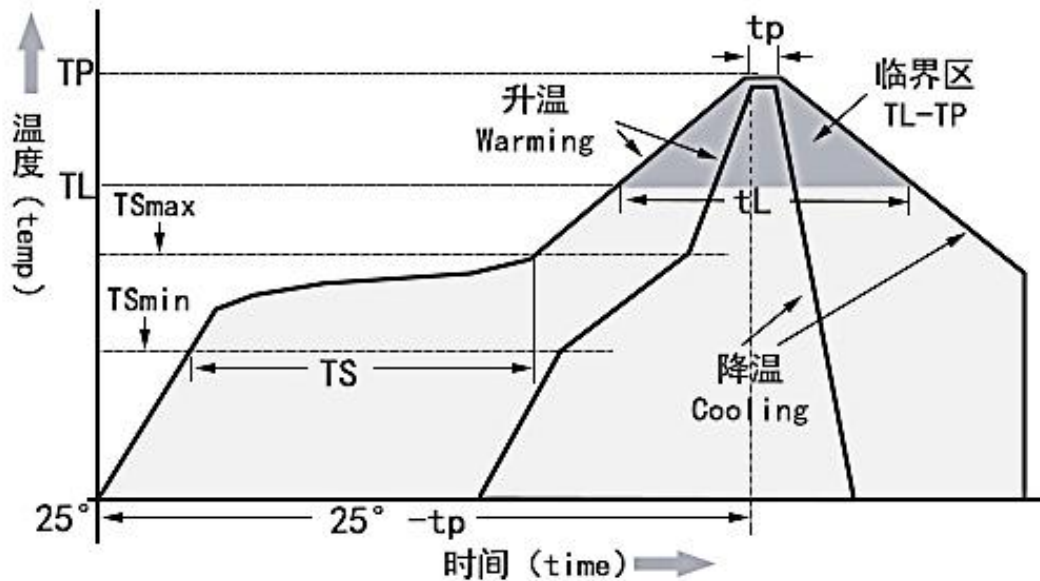

Temperature Curve Character	Lead-free solder
Average heating rate(TSmin to Tp)	最高 3°C/秒 Top 3 °C / s
Preheating: Minimum temperature (TSmin)	90°C
Preheating: Maximum temperature (TSmax)	200°C
Preheating: Time (TSmin to TSmax)	60-180 s
Duration above temperature: Temperature TL	240°C
Duration above temperature: Time tL	60-150 s
Peak/classification temperature (Tp)	260°C
Time within 5°C of actual peak temperature (tp)	20-40 s
Cooling speed	最高 6°C/秒 The highest 6 °C / s
Time to reach peak temperature at 25°C	最多 8 分钟 8 minutes Max

10. Cautions

1. Electrostatic Treatment

Do a full range of anti-static measures (such as: anti-static ring, anti-static clothes, machine, equipment grounding wire, etc.)



2. Heat Dissipation

- A、 It is recommend to configure reasonable heat dissipation device for the product.
- B、 The best working temperature range of the product is 40-60°. It is recommended to control the working temperature of the product within a reasonable range.

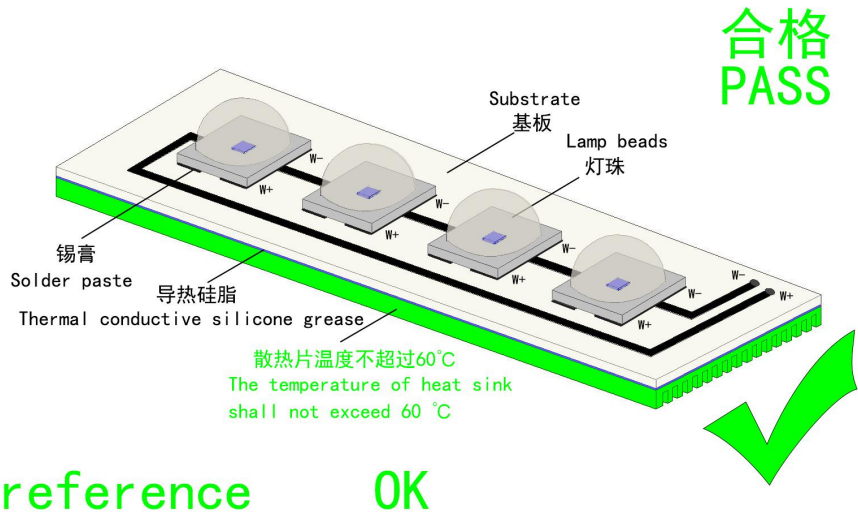

3. Installation Conditions

- A、 Do not exert any pressure on the LED area during the use of the led beads.such as below:

